



20/21

CATÁLOGO
CATALOG

Fuelles de suspensión
Air Spring Bellows
Muelles de suspensión
Air Springs
Muelles de cabina
Cabin Air Spring



Firestone
Fuelles y Muelles de Suspensión



Corven Autopartes Anuncia Su Alianza Estratégica con Firestone Productos Industriales

Corven Announces Its Strategic Alliance With Firestone Industrial Products

Corven Autopartes se enorgullece en informar la alianza con Firestone Productos industriales, líder mundial en el desarrollo y la producción de resortes neumáticos para vehículos ligeros, autobuses, camiones pesados y remolques, vagones y aplicaciones industriales, con oficinas y operaciones de fabricación en cuatro continentes.

Así, Corven Autopartes tendrá la distribución de los productos industriales de Firestone en el mercado local en lo que refiere a fuelles neumáticos para sistemas de suspensión, especialmente orientado a servicio pesado, con la premisa de ofrecer el catálogo más completo del mercado.

Corven Autopartes, con casi 50 años de trayectoria industrial es el mayor grupo independiente del continente americano dedicado a la fabricación y comercialización de autopartes para todo tipo de vehículos. La empresa en los últimos años ha ampliado su línea de productos contando hoy con parrillas de suspensión, rótulas, extremos, axiales, bieletas, discos y campanas de freno, pastillas, embragues, juntas homocinéticas, semiejes, rodamientos y mazas de rueda y cajas de dirección, además de la tradicional línea de amortiguadores a fin de ofrecer una oferta integral en su rubro.

Así, en los últimos años, Corven Autopartes desarrolló un importante proceso de inversión y expansión de sus operaciones, ampliando su paquete marcario, además de su oferta de productos, a fin de ofrecer una amplia cobertura en autopartes para automóviles, pick-ups, utilitarios y vehículos pesados de uso profesional. En este marco, para Corven Autopartes, contar con los productos industriales de Firestone en su paquete marcario cobra especial significado dentro de la ambiciosa estrategia de desarrollo de negocios fijada por la compañía.

Corven is pleased to announce its alliance with Firestone Industrial Products, global leader in the development and production of pneumatic air springs for light vehicles, buses, heavy-duty trucks and trailers, rail cars and industrial applications, with offices and manufacturing operations on four continents.

Thus, Corven will be in charge of the distribution of Firestone industrial products within the local market, that is to say, of air springs for suspension systems especially targeted for heavy-duty services, under the premise of providing the most comprehensive catalogue of the market.

Having almost 50 years of experience within the industry, Corven is the greatest independent firm of the American continent, dedicated to manufacture and commercialize spare parts for every type of vehicles.

In recent years, the company has widened its product line, which now includes control arms, ball-joints, tie rod ends, sway bar links, drums and brake discs, brake pads, clutches, constant velocity joints, drive shafts, wheel bearings, wheel hubs and steering racks, as well as the traditional line of shock absorbers, in order to provide a comprehensive range of products.

Therefore, in recent years, Corven has developed a substantial investment and expansion process related to its operations, which includes the broadening of its trademark package and product offering, in order to provide a wide coverage of spare parts for cars, pick-ups, sport-utility and heavy-duty vehicles for professional use. In this context, having Firestone industrial products within its trademark package implies a special meaning for Corven, taking into account the ambitious business strategy set by the company

Sección Institucional

Corporate Information

El verdadero valor de un líder / <i>A Leader's True Value</i>	P.4
Calidad / <i>Quality</i>	P.4
Confiabilidad / <i>Reliability</i>	P.5
Servicio / <i>Service</i>	P.5
El líder desde el primer día: una historia de innovación / <i>Leader from the beginning: A history of innovation</i>	P.6
Una mejor manera de construir lo mejor / <i>A better way to build the best</i>	P.8
Sostenibilidad / <i>Sustainability</i>	P.8
Certificaciones de Calidad / <i>Quality Certifications</i>	P.8
Estructura de los Muelles Neumáticos / <i>Structure of the pneumatic springs</i>	P.9
Componentes / <i>Components</i>	P.9

Catálogo de Aplicaciones

Application Catalog

Fuelles de Suspensión / <i>Single Air Spring Bellows</i>	P.10
Fuelles Bilobulares / <i>Double convoluted Air Spring Bellows</i>	P.12
Fuelles Trilobulares / <i>Triple convoluted Air Spring Bellows</i>	P.13
Conjunto Armado / <i>Air Spring Set</i>	P.15
Muelles / <i>Air Springs</i>	P.15
Muelles de Cabina / <i>Cabin Air Springs</i>	P.18
Muelles con Amortiguador de Cabina / <i>Air Springs with Cabin Shock Absorbers</i>	P.19

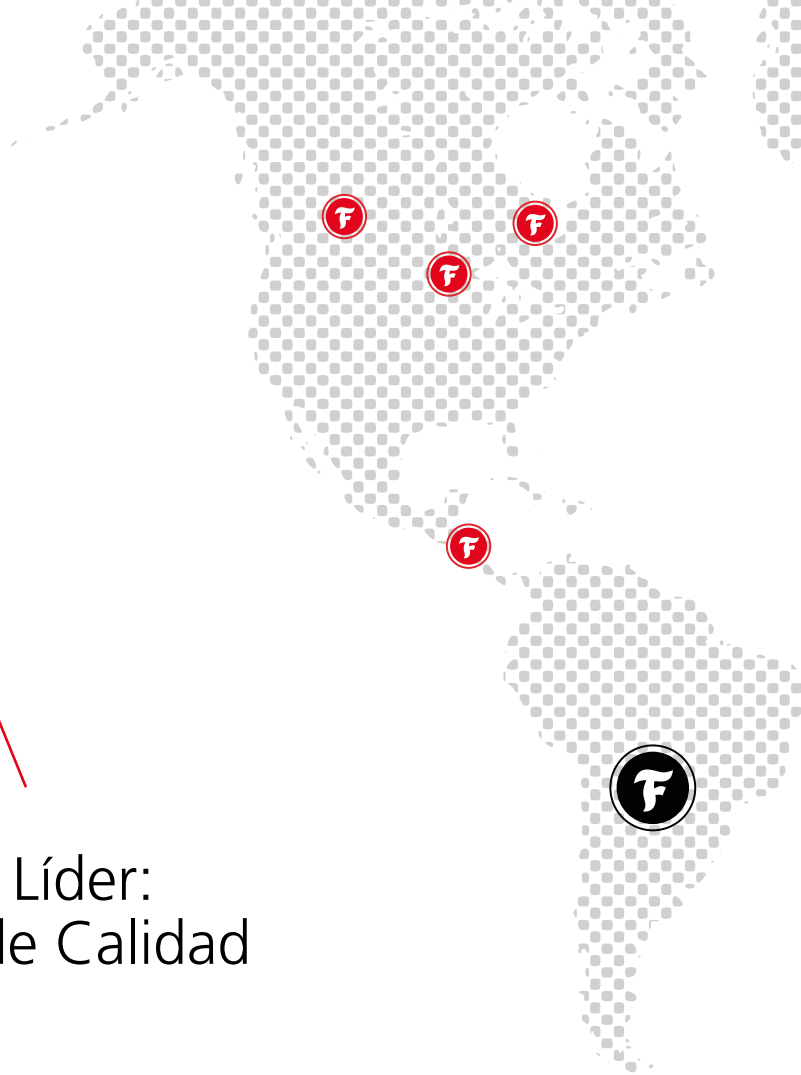

El Verdadero Valor de un Líder: Confiabilidad y Servicio de Calidad

A Leader's True Value: Quality, Reliability and Service

La marca Firestone es internacionalmente conocida y respetada. Somos el líder de la industria con una gran base de clientes que nos enorgullece llamar leales. Entonces, ya sea que esté buscando solucio-

Firestone is an internationally known and respected brand. We are the industry leaders and we are proud to have a large and loyal customer base. Therefore, if you are looking for OEM, after-sales or

nes OEM, de posventa o de aplicaciones industriales, puede confiar en la calidad, confiabilidad y un servicio incomparable de Firestone. Es un valor para el largo recorrido.

industrial applications solutions, you can trust Firestone's quality, reliability and unrivalled service. It is a value for the long haul.

Calidad Quality

Los productos industriales Firestone están diseñados para cumplir con los estándares locales más estrictos, a nivel mundial. Diseñamos y fabricamos cada producto para proporcionar años y miles de kilómetros de servicio sin problemas. Nuestro amplio proceso de desarrollo de productos ha dado como resultado la aplicación de tecnología automotriz a nuestros productos de servicio pesado.

Firestone industrial products are designed to meet the strictest local standards worldwide. We design and manufacture each product in order to provide years and thousands of kilometers of trouble-free service. Our extensive product development process has resulted in the automotive technology application in our heavy-duty products. Our

Nuestras innovaciones abarcan muchas tecnologías adicionales, desde sensores electrónicos hasta tejidos y compuestos de mayor resistencia, además de pruebas rigurosas sin comparación por parte de cualquier otro fabricante. Es una preocupación por la calidad que solo puede esperar de un líder. Visite nuestros centros de innovación y tecnología en cualquier momento para verlo usted mismo.

innovations include several additional technologies, from electronic sensors to fabrics and compounds with a greater resistance, as well as a rigorous testing that no other manufacturers can match. It is a concern for quality that only leaders have. If you want to see that for yourself, you can visit our innovation and technology centers at any time.

Confiabilidad

Reliability

Los productos industriales de Firestone le permiten comprar con confianza. Nadie tiene estándares de producción y pruebas más exigentes que nosotros. De hecho, los resortes de aire de Firestone a menudo superan a otros elementos de mantenimiento de su suspensión, como bujes, válvulas de

Firestone industrial products can be bought with confidence. Our testing and production standards are the most stringent of the market. In fact, Firestone air springs often excel other suspension products, such as bushings, levelling valves or

nivelación o reguladores. Es un compromiso que estamos dispuestos a cumplir. No solo contamos con una garantía líder en la industria, también contamos con las tasas de reclamo de garantía más bajas en la industria. Por lo tanto esa es la confiabilidad con la que puede contar.

regulators. This is a commitment that we are willing to fulfill. Not only we have an industry-leading warranty, but also the lowest warranty claim rates of the market. Therefore, this is the level of reliability that you can count on.

Servicio

Service

Firestone Industrial Products tiene el servicio global para que coincida con nuestra producción mundial. Desde nuestros ingenieros hasta nuestra línea de servicio al cliente, nos esmeramos en ser un verdadero socio, no solo un proveedor. Como solucionadores de problemas, nuestra

Firestone Industrial Products has the global service to match our global production. From our engineers to our customer service line, we strive not only to be a supplier but also a true partner. As problem solvers, our experience encompasses

experiencia se extiende a su negocio en general, no solo a la tecnología de pulmones neumáticos. Nuestro departamento de ingeniería es su departamento de ingeniería y si no hacemos lo que necesita, podemos diseñarlo.

your business as a whole, not just air spring technology. Our engineering department is your engineering department and, if we have not yet manufactured what you need, we can design it.

El Líder desde el Primer Día: Una Historia de Innovación

Leader from the Beginning: A History of Innovation

Firestone Industrial Products Company comenzó en 1936, cuando Firestone Tire & Rubber Company compró una planta en Noblesville, Indiana. Dos años después, diseñamos y patentamos el primer dispositivo de suspensión neumática, más conocido como el resorte de aire Firestone Airide™. Desde ese momento, lideramos el mercado en innovación y expansión. Hoy en día, fabricamos el resorte neumático número uno del mundo para vehículos ligeros, autobuses, camiones pesados y remolques, vagones y aplicaciones industriales, con oficinas y operaciones de fabricación en cuatro continentes.

Firestone Industrial Products Company was founded in 1936, when Firestone Tire & Rubber Company purchased a plant in Noblesville, Indiana. Two years later, we designed and patented the first pneumatic suspension device, commonly known as Firestone Airide™ air spring. From that moment on, we have been leading the market in innovation and expansion. Nowadays, we manufacture the number one air spring in the world for light vehicles, buses, heavy-duty trucks and trailers, rail cars and industrial applications, and have offices and manufacturing operations on four continents.



1950 / 1960 ■

- Los resortes de aire reemplazan los resortes de acero como el accesorio OEM en los nuevos autobuses.
- Los resortes estilo 1X con pistones estampados de acero se venden para aplicaciones automotrices.
- El resorte de aire sellado estilo 1T se comercializa.
- La producción comienza en muelles de aire de vagones para trenes.

- *Air springs replace steel springs as OEM spare parts on new buses.*
- *1X-style springs with steel stamped pistons are sold for automotive applications.*
- *The sealed 1T style air spring is commercialized.*
- *Production starts on rail car air springs for trains.*

■ 1970

- Se inicia la producción de muelles de aire para taxis y asientos de camiones pesados.
- Las ofertas de productos se expanden con la compra de resortes Ride-Rite y ayudantes de aire para vehículos livianos.
- Comienza la distribución del producto de posventa.
- Las operaciones se internacionalizan con la apertura de una oficina de ventas en Londres.
- La planta de fabricación en Sao Paulo, Brasil, comienza a producir.
- El pistón de plástico se introduce en el mercado.

- *The production of air springs for heavy-duty truck cabs and seats begins.*
- *Product offers spread with the purchase of Ride-Rite and air helper springs for light-duty vehicles.*
- *The aftermarket product distribution starts.*
- *With the opening of a sales office in London, operations become internationalized.*
- *The manufacturing plant of Sao Paulo, Brazil, begins production.*
- *The plastic piston is placed on the market.*

1980

- Firestone Industrial Products se une a la familia Bridgestone.
- El sensor de altura interno ultrasónico está patentado, lo que se suma a la seguridad del resorte de aire.
- El resorte de aire para la suspensión delantera de aire se desarrolla.
- Se abren las plantas de fabricación en Williamsburg, Kentucky y Dyersburg, Tennessee.

- *Firestone Industrial Products becomes part of the Bridgestone family.*
- *The ultrasonic internal height sensor is patented. This adds to air spring safety.*
- *The air spring for front air suspension is developed.*
- *Manufacturing plants in Williamsburg, Kentucky and Dyersburg, Tennessee, are opened.*

1990

- La organización logra la certificación ISO 9000 y QS 9000.
- Firestone amplía la línea de productos de ayuda para el aire del automóvil con el resorte Coil-Rite instalado en el diámetro interior de un muelle helicoidal.

- *The organization obtains ISO 9000 and QS 9000 certifications.*
- *Firestone expands its automotive air helper product line with the Coil-Rite spring installed inside the inner diameter of a helical coil spring.*

1980's

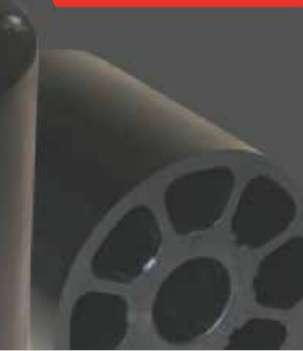

1990's



2000's



2000

- Se abre la planta de fabricación en Wolsztyn, Polonia.
- La sede mundial se traslada a Indianápolis, Indiana.
- Beijing Firestone Air Spring, LLC comienza el montaje en China.
- Se abre la oficina de ventas de Delhi, India.
- Firestone TVS, una empresa conjunta entre Firestone y Sundaram Industries, miembro del Grupo TVS, abre una planta de fabricación en Madurai, India.
- Se inaugura la planta manufacturera de Costa Rica.
- Se abre el centro de distribución de Singapur.
- Work-Rite y el sistema de gestión de carga de nivel de entrada se introduce en el mercado secundario.
- La producción comercial de manantiales ferroviarios comienza en la planta de Madurai, India.

- *A manufacturing plant is opened in Wolsztyn, Poland.*
- *Worldwide headquarters moves to Indianapolis, Indiana.*
- *Beijing Firestone Air Spring, LLC, begins assembly in China.*
- *A sales office is opened in Delhi, India.*
- *Firestone TVS, a joint enterprise between Firestone and Sundaram Industries, a member of the TVS Group, opens a manufacturing plant in Madurai, India.*
- *A manufacturing plant is opened in Costa Rica.*
- *A distribution center is opened in Singapore.*
- *The Work-Rite and the entry-level load management system are placed in the secondary market.*
- *Commercial production of railway springs begins in the manufacturing plant placed in Madurai, India.*

Firestone

Una Mejor Manera de Construir lo Mejor

A Better Way to Build the Best

Firestone Industrial Products no solo construye productos. Somos una entidad global con una responsabilidad hacia las comunidades en las que vivimos y trabajamos y en la tierra en la que estamos parados. Es una responsabilidad que no tomamos a la ligera.

Firestone Industrial Products does not only build products. We are a global company with responsibility towards the communities where we live and work, and the ground we stand on. It is a responsibility we do not take lightly.

Sostenibilidad

Sustainability

Como líder global, Firestone Industrial Products se da cuenta de que todo lo que hacemos tiene un impacto en nuestro mundo. Nos esforzamos por ser administradores del medio ambiente y continuar actualizando nuestros procesos y materiales para reducir aún más nuestra huella de carbono. Nuestros esfuerzos incluyen el uso de recubrimien-

tos metálicos respetuosos con el medio ambiente y programas de reciclaje en nuestras plantas de fabricación, así como la investigación sobre el uso de materiales reciclados en nuestros productos. Desde 2002, hemos iniciado procesos de Six Sigma para mejorar la calidad y reducir los desechos.

As a worldwide leader, Firestone Industrial Products realizes that everything we do has an impact on our world. We strive to be stewards of the environment and continue updating our processes and materials in order to further reduce our carbon footprint. Our efforts include the use of eco-friendly metal

coatings and recycling programs in our manufacturing plants, as well as studying the use of recycled materials in our products. Since 2002, we have initiated Six Sigma processes in order to improve quality and reduce waste.

Certificaciones de Calidad

Quality Certifications

Continuamente nos esforzamos por tener las instalaciones más eficientes, de mayor rendimiento y ecológicas posibles. Nuestras oficinas e instalaciones de fabricación han llevado a cabo estrictos programas de certificación de control de calidad

que incluyen las normas del sistema de gestión de calidad ISO 9001 y TS 16949, además de las normas del sistema de gestión ambiental ISO 14001.

We constantly strive to have the most efficient, highest performing and eco-friendliest facilities as possible. Our offices and manufacturing facilities have carried out strict quality control certification

programs, which include ISO 9001 and TS 16949 quality management system standards, as well as the ISO 14001 environmental management system standards.

Estructura de los Muelles Neumáticos

Firestone

Structure of the pneumatic springs

Los fuelles de suspensión de Firestone son fabricados con caucho de altísima calidad y tecnología de punta, y además del caucho, los fuelles tienen en su composición tejidos de alta resistencia.

- Dos capas de lona (tejido de poliamida y/o poliéster)
- Dos capas de compuesto de caucho

Optima resistencia a la aplicación de altas cargas

Firestone air springs bellows are manufactured with high quality rubber and state-of-the-art technology, and besides rubber, the bellows have high resistance fabrics in their composition.

- Two layers of canvas (polyamide and / or polyester fabric)
- Two layers of rubber compound

Optimal resistance to the application of high loads

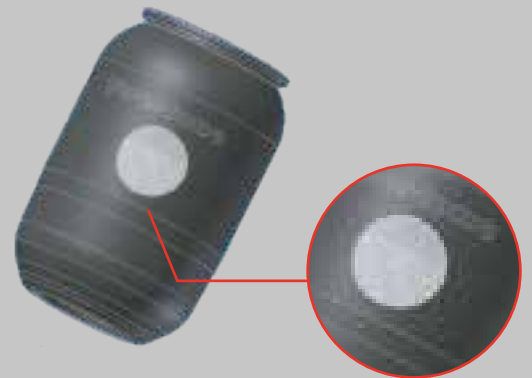

COMPONENTES COMPONENTS



El muelle neumático y el conjunto formado por el fuelle de suspensión (cuerpo del caucho y tejido) y las partes metálicas que se pueden observar más abajo:

The pneumatic spring and kits are formed by air spring bellows (body of rubber and fabric) and the metal parts that can be seen below:

1. Prisonero de fijación / Fixation prisoner
2. Conexión de aire / Air connection
3. Plato superior / Top plate
4. Fuelle / Bellows
5. Tope de rebote / Bounce stop
6. Pistón Base / Base Piston
7. Tornillo de fijación / Fixing screw







Los kits están compuestos por los mismos componentes descritos arriba con excepción del pistón base.



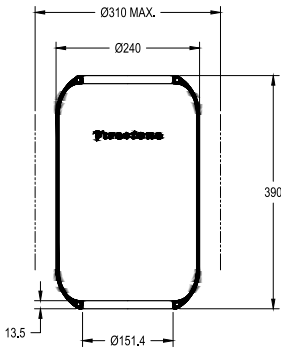

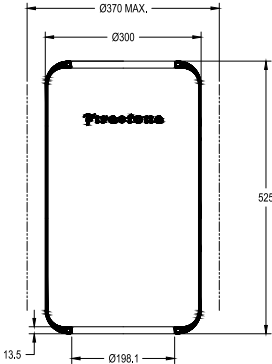

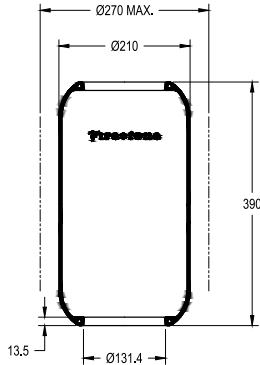
The kits are composed of the same components described above with the exception of the base piston

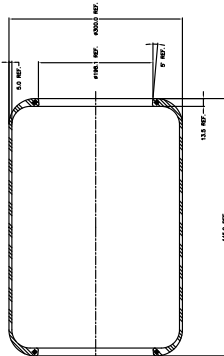

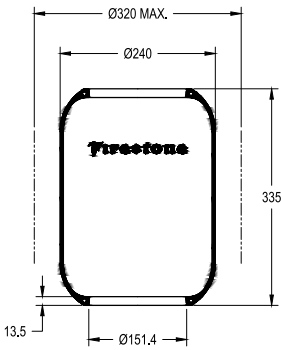

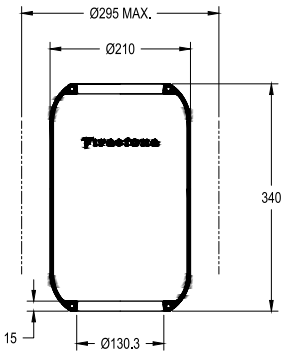

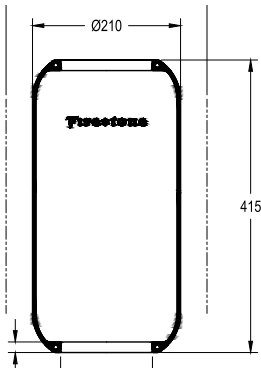
En el catálogo de Firestone es posible observar los códigos para resortes (muelles) neumáticos, fuelles y kits.

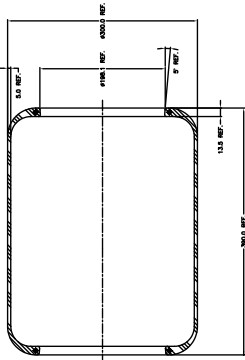





In the Firestone catalog it is possible to observe the codes for pneumatic springs (springs), bellows and kits.

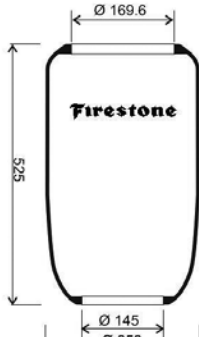

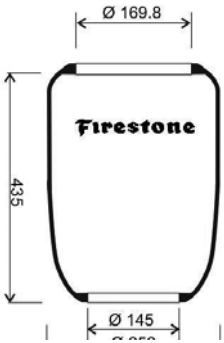

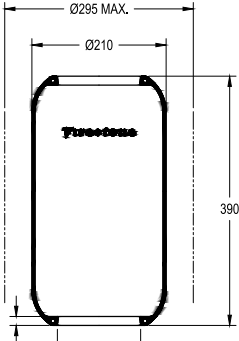

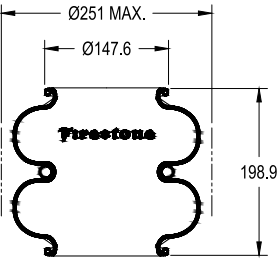
Consulte sobre cuáles son los productos disponibles en kits en el mercado local.
Ask about the products available in kits in the local market.



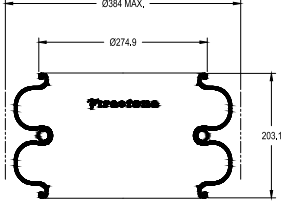

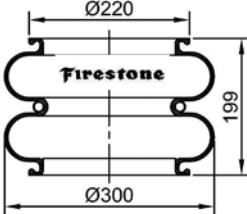

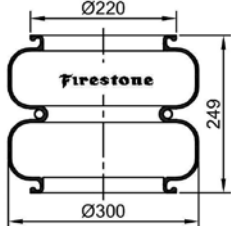
APLICACIÓN / APPLICATION		CONTITECH	GOODYEAR	FERVI AIR	MONTIBAL	NEUMACARG
950021 FUELLES DE SUSPENSIÓN / SINGLE AIR SPRING BELLOWS 1R1C-390-310						
		VOLVO IMEDT	661 N	556088018	01-2020	30-151-390 T240-151-390
950115 FUELLES DE SUSPENSIÓN / SINGLE AIR SPRING BELLOWS 1R1G 525-370 FF						
		RANDON SCANIA SEMIS / SEMI-TRAILER - ACOPLADOS / TRAILER	811 N	556038038	01-0340	32-195-535 T300-195-525
950121 FUELLES DE SUSPENSIÓN / SINGLE AIR SPRING BELLOWS 1R1B-390-270						
		DEUTZ OA 101 SCANIA K112 /K113 / L113 TRAS / REAR AGRALE MT15 DEL/TRAS - FRONT/REAR AGRALE MT12 DEL / FRONT	-	556038016	01-0010	2B-131-390 T210-130-390
950132 FUELLES DE SUSPENSIÓN / SINGLE AIR SPRING BELLOWS 1R1G-445-370						
		BOERO SEMIS ACOPLADOS MB OHL 1635 TRAS MB OHL 1621 TRAS	810 N	556038031	01-0310	32-195-435 T300-195-445

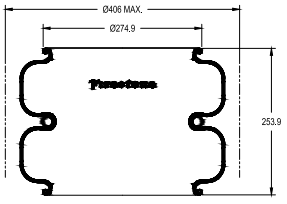

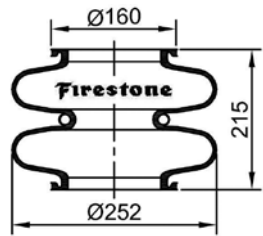

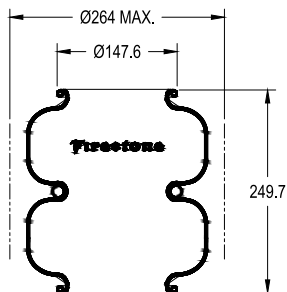

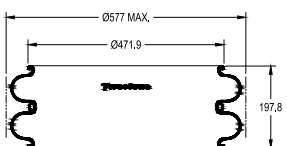
APLICACIÓN / APPLICATION		CONTITECH	GOODYEAR	FERVI AIR	MONTIBAL	NEUMACARG
950134 FUELLE / SINGLE AIR SPRING BELLOWS 1R1E 335-320						
		SCANIA K112 /K113 / L113 DEL ZANELLO DEUTZ OA 104 DEL DEUTZ OA 105 DEL/TRAS	-	556038019	01-0510	29-151-340 T240-151-335
950144 FUELLE / SINGLE AIR SPRING BELLOWS 1R1A-340-295						
		SCANIA OMNIBUS	-	-	-	-
950197 FUELLE / SINGLE AIR SPRING BELLOWS 1R1A-415-285						
		MB OMNIBUS OHL 1621 DEL MB OMNIBUS OHL 1635 DEL MB OMNIBUS OH 1315 DEL MB OMNIBUS O-500 DEL / 3º EJE	782 N	556039013	01-0030	-
950214 FUELLE / SINGLE AIR SPRING BELLOWS 1R1G 390-390						
		PENTRON SEMIS ACOPLADOS	-	-	01-0330	32-195-390 T300-195-390

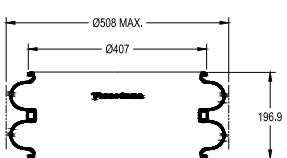

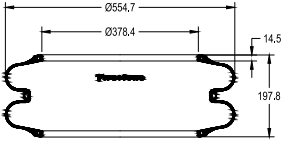

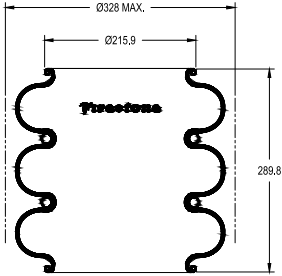

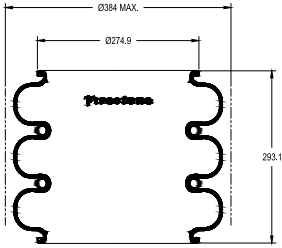
APLICACIÓN / APPLICATION		CONTITECH	GOODYEAR	FERVI AIR	MONTIBAL	NEUMACARG
950427 FUELLE / SINGLE AIR SPRING BELLOWS 1R1K-330-320						
		VW 15230 /18310 DEL. / FRONT	-	566038072	-	-
950492 FUELLE / SINGLE AIR SPRING BELLOWS 1R1E 440-340						
		VW 15230/18310 / 18320 TRAS / REAR	-	-	-	-
950505 FUELLE / SINGLE AIR SPRING BELLOWS 1R7Z-440-290-C						
		MB ACTROS 2546/2646	-	-	-	-
950679 FUELLES DE SUSPENSIÓN / SINGLE AIR SPRING BELLOWS 1R5N-525-320						
		PETINARI PENTRON BOERO SEMIS / SEMI-TRAILER ACOPLADOS / TRAILER	-	-	01-2310	31-170-140-520 TC260-170-525

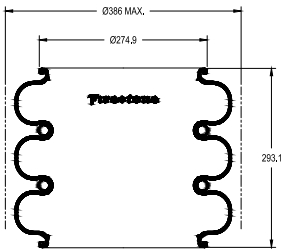

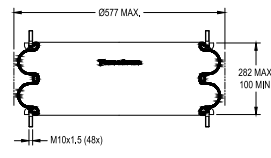

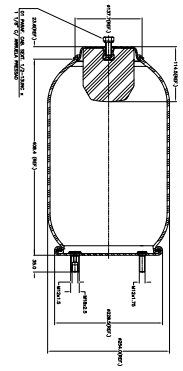

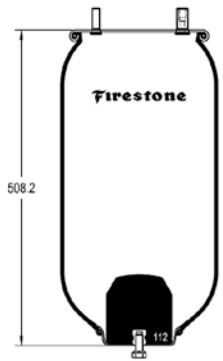
APLICACIÓN / APPLICATION		CONTITECH	GOODYEAR	FERVI AIR	MONTIBAL	NEUMACARG
950746 FUELLES DE SUSPENSIÓN / SINGLE AIR SPRING BELLOWS 1R5N-435-320						
		PENTRON SEMIS / SEMI-TRAILER ACOPLADOS / TRAILER	-	-	01-2110	31-170-140-435 TC260-170-435
954002 FUELLES DE SUSPENSIÓN / SINGLE AIR SPRING BELLOWS 1R1AF 390-295						
		MB ÓMNIBUS / BUS 1115 DEL/TRAS - FRONT/REAR MB ÓMNIBUS / BUS 1621 DEL/TRAS - FRONT/REAR MB ÓMNIBUS / BUS 1721 DEL/TRAS - FRONT/REAR MB ÓMNIBUS / BUS 1315 TRAS / REAR MB ÓMNIBUS / BUS 0-370 DEL/TRAS - FRONT/REAR MB ÓMNIBUS / BUS 0-400 DEL/TRAS - FRONT/REAR	644 N	556038017	01-0020	28-131-390MB T210-130-390.2
950009 FUELLES BILOBULARES / DOUBLE CONVOLUTED AIR SPRING BELLOWS 20						
		VOLVO B58 ARBUS TRAS / REAR ARBUS LEVANTA EJE SEMIS / TRAILER LIFT AXLE ACOPLADOS / TRAILER	895 N	556238325	01-6010	28-22-150 2C20-230
950375 FUELLES DE SUSPENSIÓN / SINGLE AIR SPRING BELLOWS 1R1E-440-320						
		IMEDT VOLKSWAGEN	-	556038313	-	-

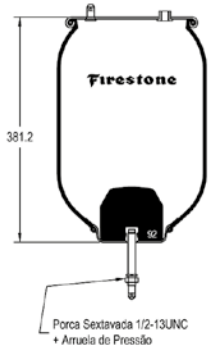

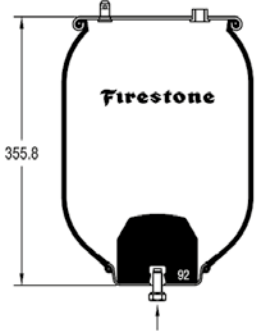

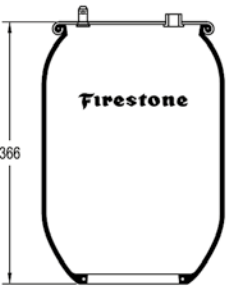

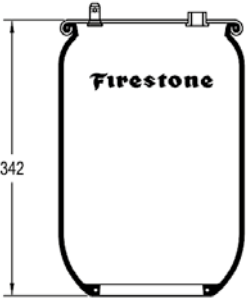
APLICACIÓN / APPLICATION		CONTITECH	GOODYEAR	FERVI AIR	MONTIBAL	NEUMACARG
950035 FUELLES BILOBULARES / DOUBLE CONVOLUTED AIR SPRING BELLOWS 21						
		LEVANTA EJE SEMIS / TRAILER LIFT AXLE ACOPADOS / TRAILER	-	556238329	01-6310	2B-33-270 2C205-355
950037 FUELLES BILOBULARES / DOUBLE CONVOLUTED AIR SPRING BELLOWS 22						
		LEVANTA EJE SEMIS / TRAILER LIFT AXLE ACOPADOS / TRAILER	-	556238316	01-6110	2B-21-220 2C210-300
950092 FUELLES BILOBULARES / DOUBLE CONVOLUTED AIR SPRING BELLOWS 22-1.5						
		LEVANTA EJE SEMIS / TRAILER LIFT AXLE ACOPADOS / TRAILER	-	556238328	01-6120	2B-26-220 2C210-300.2
950169 FUELLES BILOBULARES / DOUBLE CONVOLUTED AIR SPRING BELLOWS 21-2						
		LEVANTA EJE SEMIS / TRAILER LIFT AXLE ACOPADOS / TRAILER	-	556238336	01-6130	2B-33-270 2C205-355

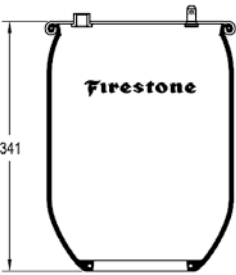

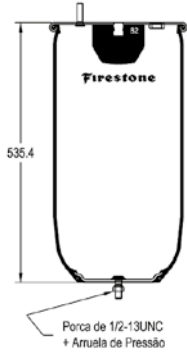

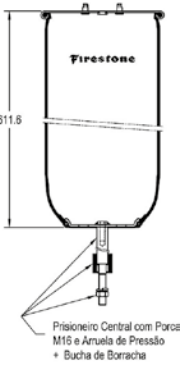

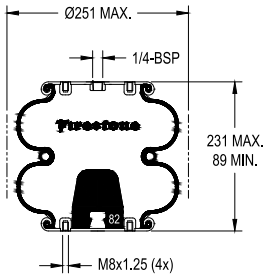
APLICACIÓN / APPLICATION		CONTITECH	GOODYEAR	FERVI AIR	MONTIBAL	NEUMACARG
950175 FUELLES BILOBULARES / DOUBLE CONVOLUTED AIR SPRING BELLOWS 10A-2F						
		ARBUS TRAS / REAR ARBUS BOERO RANDON LEVANTA EJE SEMIS / TRAILER LIFT AXLE ACOPLADOS / TRAILER	-	556238337	01-6040	2B-23-160-A 2C10A-252
950234 FUELLES BILOBULARES / DOUBLE CONVOLUTED AIR SPRING BELLOWS 20-2.0						
		VOLVO B58 ARBUS TRAS / REAR ARBUS LEVANTA EJE SEMIS / TRAILER LIFT AXLE ACOPLADOS / TRAILER	200-25	556238332	01-6020	2B-22-150L 2C20-230.2
950250 FUELLES BILOBULARES / DOUBLE CONVOLUTED AIR SPRING BELLOWS 29 SUSPENSOR						
		LEVANTA EJE SEMIS / TRAILER LIFT AXLE ACOPLADOS / TRAILER RANDON SUSPENSYS	-	556238350	01-6329	- 2C207-555
950358 FUELLES BILOBULARES / DOUBLE CONVOLUTED AIR SPRING BELLOWS 203 SUSPENSOR						
		LEVANTA EJE SEMIS / TRAILER LIFT AXLE ACOPLADOS / TRAILER RANDON SUSPENSYS	-	556238203	01-2120	- -

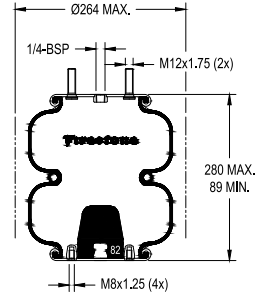

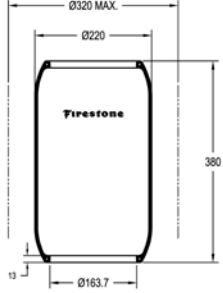

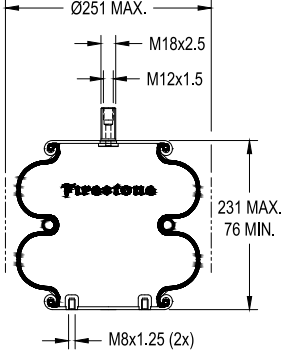

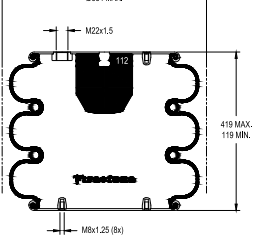
APLICACIÓN / APPLICATION		CONTITECH	GOODYEAR	FERVI AIR	MONTIBAL	NEUMACARG
950464 FUELLES BILOBULARES / DOUBLE CONVOLUTED AIR SPRING BELLOWS 290						
		LEVANTA EJE SEMIS / TRAILER LIFT AXLE ACOPLADOS / TRAILER VOLKSWAGEN RANDON	-	556238034	-	-
950047 FUELLES TRILOBULARES / TRIPLE CONVOLUTED AIR SPRING BELLOWS 38-R						
		BATEA PETINARI	-	-	-	-
950113 FUELLES TRILOBULARES / TRIPLE CONVOLUTED AIR SPRING BELLOWS 313						
		RANDON SUSPENSYS PENTRON SEMIS / SEMI-TRAILER - ACOPLADOS / TRAILER	-	556338319	01-8030	3B-33-270 3C313-355
950166 FUELLES TRILOBULARES / TRIPLE CONVOLUTED AIR SPRING BELLOWS 333						
		RANDON SUSPENSYS SEMIS / SEMI-TRAILER ACOPLADOS / TRAILER	-	556338335	01-8020	3B-33-270L 3C333-355

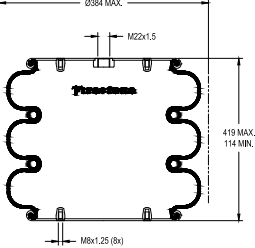

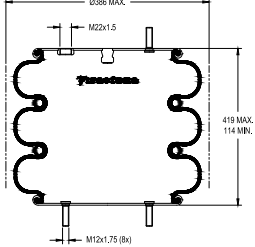

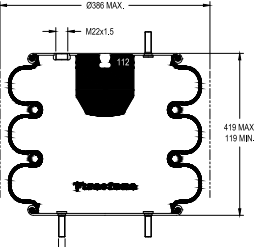

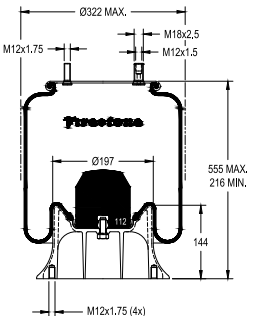
APLICACIÓN / APPLICATION		CONTITECH	GOODYEAR	FERVI AIR	MONTIBAL	NEUMACARG
950251 CONJUNTO ARMADO / AIR SPRING SET 29 SUSPENSOR TIPO 4						
		<p>3° EJE GROSS / 3° GROSS AXLE RANDON SUSPENSYS</p>	-	-	-	-
950308 KIT 1T15M-6-0308						
		<p>RANDON SUSPENSYS VW 1932 CONSTELLATION / 18310</p>	-	566028653	-	-
950309 KIT 1T15M-9-0309						
		<p>RANDON</p>	-	-	-	-
950404 KIT 1T15L-4-0404						
		<p>SCANIA K400 / K124 6 X 2</p>	-	-	-	-

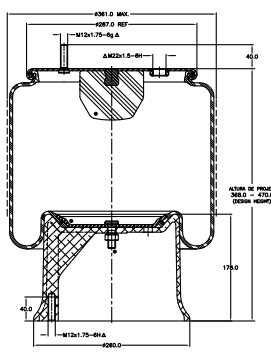

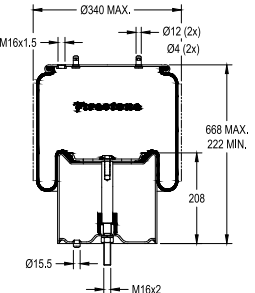

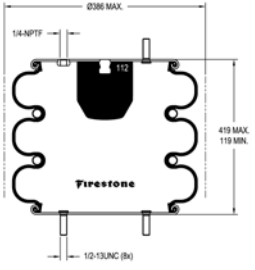

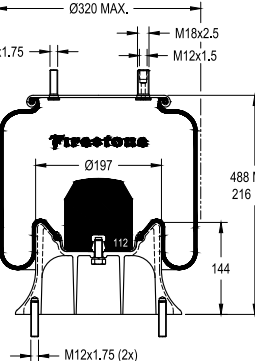
APLICACIÓN / APPLICATION		CONTITECH	GOODYEAR	FERVI AIR	MONTIBAL	NEUMACARG
950446 KIT 1T15MQX-3-0446						
		SCANIA K124 DEL / L94 DEL / FRONT	-	-	-	-
950590 KIT 1T15LR-4-0590						
		SCANIA K340/K380/K420/ K310 TRAS / REAR	-	-	-	-
950591 KIT 1T15LMR-3-0591						
		SCANIA K340/K380/K420/ K310 3° EJE / 3° AXLE	-	-	-	-
950592 KIT 1T17ARD-3-0592						
		SCANIA K340/K380/K420/ K310 DEL / FRONT	-	-	-	-

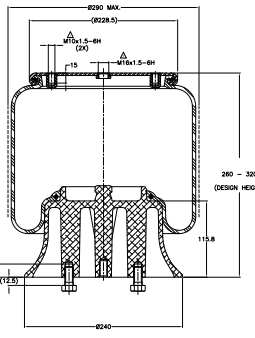

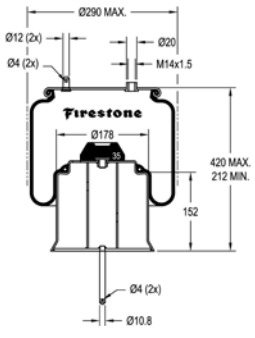

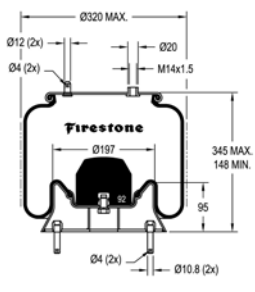

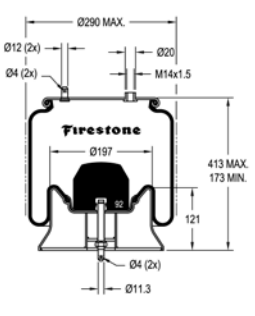
APLICACIÓN / APPLICATION		CONTITECH	GOODYEAR	FERVI AIR	MONTIBAL	NEUMACARG
950735 KIT 1T19L-11-0321						
	 <p>535.4</p> <p>Porca de 1/2-13UNC + Anilha de Pressão</p>	RANDON	-	-	-	-
950741 KIT 1T19F14-0741						
	 <p>611.8</p> <p>Pistoneiro Central com Porca M16 e Anilha de Pressão + Bucha de Borracha</p>	SCANIA P / G / R	-	-	-	-
950285 MUELLES / AIR SPRINGS 20-0285 T.3						
	 <p>Ø251 MAX.</p> <p>1/4-BSP</p> <p>231 MAX. 89 MIN.</p> <p>M8x1.25 (4x)</p>	LEVANTA EJE SEMIS / TRAILER LIFT AXLE ACOPLADOS / TRAILER	-	-	-	-
950327 MUELLES / AIR SPRINGS 20-2-0327 T.3						
	 <p>Ø264 MAX.</p> <p>1/4-BSP</p> <p>M12x1.75 (2x)</p> <p>280 MAX. 89 MIN.</p> <p>M8x1.25 (4x)</p>	PENTRON	64552	578923206	-	-

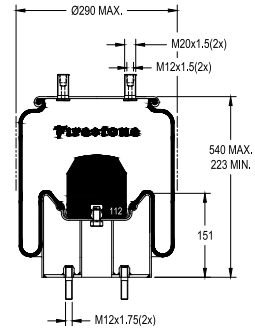

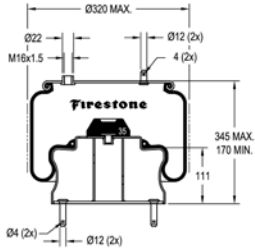

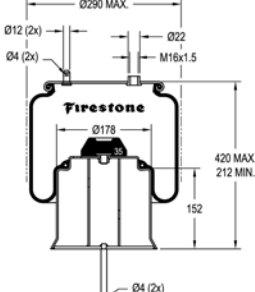

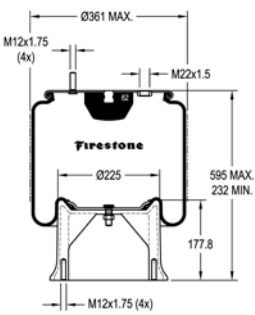
APLICACIÓN / APPLICATION		CONTITECH	GOODYEAR	FERVI AIR	MONTIBAL	NEUMACARG
950339 MUELLE / AIR SPRINGS 1R1K-380-320 BASE ACERO						
		VW 17240/17260 DEL / FRONT	-	-	-	-
950353 MUELLE / AIR SPRINGS 20-0353						
		RANDON SUSPENSYS BOERO VOLVO NH12-FH12	-	-	-	-
950271 MUELLES / AIR SPRINGS 313-0271 T.2						
		LEVANTA EJE SEMIS / TRAILER LIFT AXLE ACOPLADOS / TRAILER	-	-	-	-
950272 MUELLES / AIR SPRINGS 313-0272 T.2						
		LEVANTA EJE SEMIS / TRAILER LIFT AXLE ACOPLADOS / TRAILER	-	-	-	-

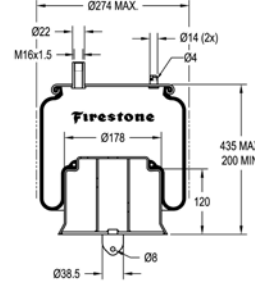
APLICACIÓN / APPLICATION		CONTITECH	GOODYEAR	FERVI AIR	MONTIBAL	NEUMACARG
950338 MUELLES / AIR SPRINGS 333-0338 T.2						
		LEVANTA EJE SEMIS / TRAILER LIFT AXLE ACOPLADOS / TRAILER	-	-	-	-
950352 MUELLES / AIR SPRINGS 333-0352 T.2						
		LEVANTA EJE SEMIS / TRAILER LIFT AXLE ACOPLADOS / TRAILER	-	-	-	-
950314 MUELLES / AIR SPRINGS 1T15M-9-0314						
		PENTRON	64331	556243066	-	-
950320 MUELLE / AIR SPRINGS 1T189L-11-0320						
		RANDON SUSPENSYS	-	-	-	-

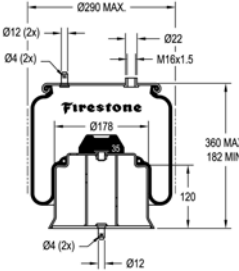

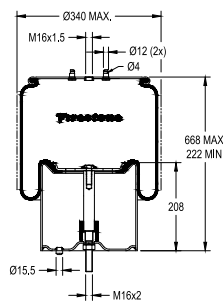

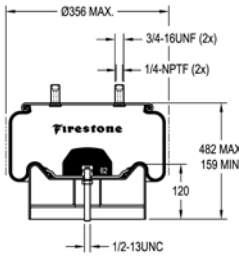

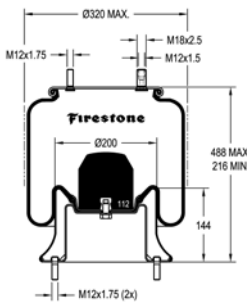
APLICACIÓN / APPLICATION		CONTITECH	GOODYEAR	FERVI AIR	MONTIBAL	NEUMACARG
950366 MUELLES / AIR SPRINGS 1T19F-14-0366						
		SCANIA T124/E94/R420/ R470/R500	-	-	-	-
950380 MUELLE / AIR SPRINGS 333-0380 T.2						
		LEVANTA EJE SEMIS ACOP- LADOS / TRAILER LIFT AXLE	-	-	-	-
950420 MUELLE / AIR SPRINGS 1T15M-6-0420						
		RANDON SUSPENSYS VW 18310 / 19320 CONSTELLATION	-	-	-	-
950455 MUELLE / AIR SPRINGS 1T15LR-4-0455						
		950455 MUELLE / AIR SPRINGS 1T15LR-4-0455	-	-	-	-



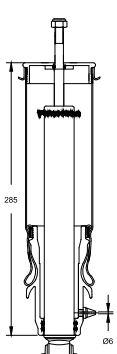

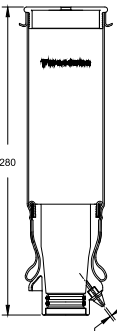

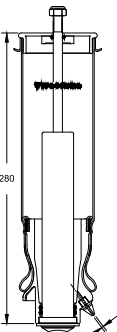
APLICACIÓN / APPLICATION		CONTITECH	GOODYEAR	FERVI AIR	MONTIBAL	NEUMACARG
950481 MUELLE / AIR SPRINGS 1T15LR-4-0481 BASE ACERO						
		<p>SCANIA L94/ K-400 TRAS / REAR</p>	-	-	-	-
950482 MUELLE / AIR SPRINGS 1T15MQX-3-0482 BASE ACERO						
		<p>SCANIA K124 DEL / L94 DEL / FRONT</p>	-	-	-	-
950484 MUELLE / AIR SPRINGS 1T15L-4-0484 BASE ACERO						
		<p>SCANIA K-400 / K124 DEL / FRONT</p>	64331	556243066	-	-
950490 MUELLES / AIR SPRINGS 1T15M-8-0490						
		<p>RANDON SUSPENSYS</p>	-	-	-	-

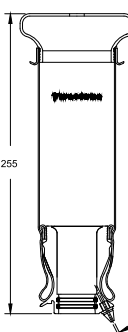

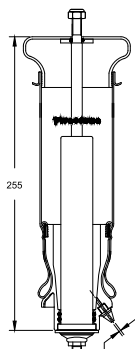

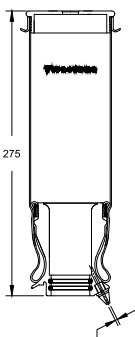

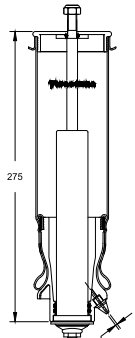
APLICACIÓN / APPLICATION		CONTITECH	GOODYEAR	FERVI AIR	MONTIBAL	NEUMACARG
950565 MUELLE / AIR SPRINGS 1T17ARD-3-0565 BASE ACERO						
		SCANIA K340/K380/K420 / K310 DEL / FRONT	-	-	-	-
950567 MUELLE / AIR SPRINGS 1T15LR-4-0567 BASE ACERO						
		SCANIA K340/K380/K420/ K310 DEL / FRONT	-	-	-	-
950570 MUELLE / AIR SPRINGS 1T19L-11-0570 BASE ALUMINIO						
		LEVANTA EJE SEMIS ACOP- LADOS / TRAILER LIFT AXLE	-	-	-	-
950571 MUELLE / AIR SPRINGS 1T15LMR-3-0571 BASE ACERO						
		VOLVO B12 R/ B12 M TRAS. / REAR	-	-	-	-

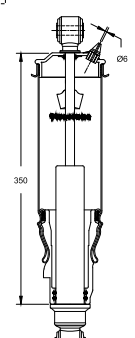

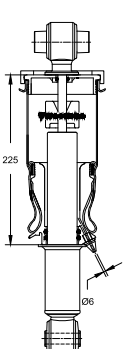

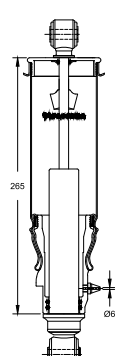

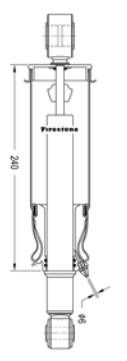
APLICACIÓN / APPLICATION		CONTITECH	GOODYEAR	FERVI AIR	MONTIBAL	NEUMACARG
950576 MUELLE / AIR SPRINGS 1T15LMR-3-0576 BASE ACERO						
		<p>SCANIA K340/K380/K420/ K310 3° EJE / 3° AXLE</p>	-	-	-	-
950595 MUELLES / AIR SPRINGS 1T19F-14-0595						
		<p>SCANIA P-340 LA 6X2</p>	-	-	-	-
950627 MUELLE / AIR SPRINGS 1T19LC-6-0627 BASE ACERO						
		<p>HENDRICKSON TRAILER</p>	-	-	-	-
950663 MUELLE / AIR SPRINGS 1T15M-6-0663 BASE ACERO						
		<p>VW 18310/19320 CONSTELATION RANDON</p>	-	-	-	-

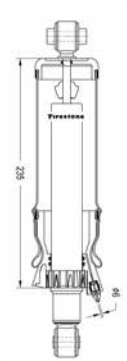
APLICACIÓN / APPLICATION		CONTITECH	GOODYEAR	FERVI AIR	MONTIBAL	NEUMACARG
950880 MUELLE / AIR SPRINGS W02-M58-8472 BASE ACERO						
	VOLVO FH12 / FH16 TRAS / REAR	-	-	-	-	-
950881 MUELLE / AIR SPRINGS W02-M58-8474 BASE ACERO						
	VOLVO FH12 / FH16 TRAS / REAR	-	-	-	-	-
954010 MUELLE / AIR SPRINGS 1T19LLJ-14-4010 BASE ACERO						
	SCANIA SERIE P/G/R	-	-	-	-	-
950850 MUELLES DE CABINA / CABIN AIR SPRINGS W02-M58-8000						
	SCANIA SERIE 4 / 93-113-143	-	-	-	-	-

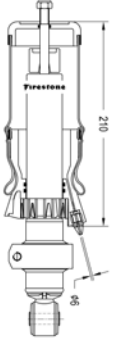
APLICACIÓN / APPLICATION		CONTITECH	GOODYEAR	FERVI AIR	MONTIBAL	NEUMACARG
950851 MUELLES CON AMORTIGUADOR DE CABINA / AIR SPRINGS WITH CABIN SHOCK ABSORBERS W02-M58-8001						
		SCANIA SERIE 4 / 93-113-143	-	-	-	-
950852 MUELLES DE CABINA / CABIN AIR SPRINGS W02-M58-8002						
		SCANIA SERIE 4 / 93-113-143	-	-	-	-
950853 MUELLES CON AMORTIGUADOR DE CABINA / AIR SPRINGS WITH CABIN SHOCK ABSORBERS W02-M58-8004						
		SCANIA SERIE 4 / 93-114-144	-	-	-	-
950854 MUELLES DE CABINA / CABIN AIR SPRINGS W02-M58-8005						
		SCANIA SERIE 4 / 93-114-144	-	-	-	-

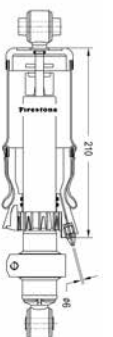
APLICACIÓN / APPLICATION		CONTITECH	GOODYEAR	FERVI AIR	MONTIBAL	NEUMACARG
950855 MUELLES CON AMORTIGUADOR DE CABINA / AIR SPRINGS WITH CABIN SHOCK ABSORBERS W02-M58-8006						
		SCANIA SERIE 4 / 93-114-144	-	-	-	-
950856 MUELLES DE CABINA / CABIN AIR SPRINGS W02-M58-8008						
		SCANIA SERIE R	-	-	-	-
950857 MUELLES CON AMORTIGUADOR DE CABINA / AIR SPRINGS WITH CABIN SHOCK ABSORBERS W02-M58-8009						
		SCANIA SERIE R	-	-	-	-
950858 MUELLES CON AMORTIGUADOR DE CABINA / AIR SPRINGS WITH CABIN SHOCK ABSORBERS W02-M58-8036						
		VOLVO FH12-FH16	-	-	-	-

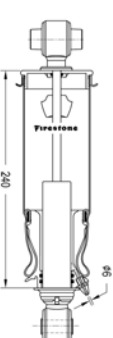
APLICACIÓN / APPLICATION		CONTITECH	GOODYEAR	FERVI AIR	MONTIBAL	NEUMACARG
950859 MUELLES CON AMORTIGUADOR DE CABINA / AIR SPRINGS WITH CABIN SHOCK ABSORBERS W02-M58-8037						
		VOLVO FH12-FH17	-	-	-	-
950860 MUELLES CON AMORTIGUADOR DE CABINA / AIR SPRINGS WITH CABIN SHOCK ABSORBERS W02-M58-8038						
		VOLVO FH12-FH18	-	-	-	-
950919 MUELLE DE CABINA / CABIN AIR SPRINGS W02-M58-8022						
		IVECO STRALIS DEL / FRONT	-	-	-	-
950921 MUELLE DE CABINA / CABIN AIR SPRINGS W02-M58-8024						
		IVECO STRALIS TRAS / REAR	-	-	-	-

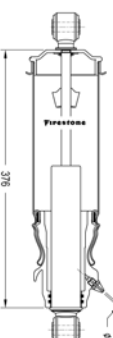
APLICACIÓN / APPLICATION	CONTITECH	GOODYEAR	FERVI AIR	MONTIBAL	NEUMACARG		
950922 MUELLE DE CABINA / CABIN AIR SPRINGS W02-M58-8029							
		IVECO EUROTECH TRAS / REAR	-	-	-	-	-
950923 MUELLE DE CABINA / CABIN AIR SPRINGS W02-M58-8025							
		IVECO EUROTECH TRAS / REAR	-	-	-	-	-
950925 MUELLE DE CABINA / CABIN AIR SPRINGS W02-M58-8026							
		IVECO STRALIS TRAS / REAR	-	-	-	-	-
950926 MUELLE DE CABINA / CABIN AIR SPRINGS W02-M58-8014							
		MB ACTROS DEL / FRONT	-	-	-	-	-

LA SOLUCIÓN MÁS COMPLETA EN AUTOPARTES

CORVEN[®]
Autopartes

50
AÑOS



**Diseño,
Desarrollo y
Homologación
de Producto**

**Calidad
Certificada**

**Asistencia
Técnica**

**Stock
Permanente**

**Atención al
Cliente /
Rápida
Entrega**

Marcas Representadas

CORVEN[®]
Autopartes

AP AUTOMOTIVE
PRODUCTS

Firestone
Fuelles y Muelles de Suspensión

Bendix[®]

Valeo

SADAR
AMORTIGUADORES

Lip

**MAIS QUE FREIOS
Hipper Freios**

FTE
automotive

STABILUS

www.corven.com.ar

Firestone

Distribuye y Garantiza en Argentina:



www.corven.com.ar